

For New Technology Network

**NTN**®

NTNcorporation

# Insulated Bearings **MEGAOHM™** Series

CAT. No. 3030/E



# Insulated Bearings MEGAOHM™ Series : Offering Enhanced Safety and Reliability

Bearings used in electrical equipment such as motors and power generators tend to exhibit electrical pitting as a result of current leakage. NTN's MEGAOHM™ Series of insulated bearings has been specifically designed to counteract electrical pitting. These bearings are available in both ceramic and resin types suited to a variety of applications. The MEGAOHM™ Series of insulated bearings offers the following unique advantages:

## MΩ series

- Exhibits insulation resistance of at least 100 MΩ at 500 VDC.
- Available in a wide range of variants with various insulating layer materials, high voltage resistance and shock immunity that accommodate diverse user requirements.
- Compatible with ISO 492, DIN 620 and JIS 1514 standards.
- Available in bore diameters ranging from 50 to 160 mm.



## 1 The Mechanism of Electrical Pitting

An electrical current present near a bearing can flow to the inside of the bearing, causing sparks that damage the rolling contact surface. This phenomenon is known as "electrical pitting." When such sparks first occur, circular spots can appear on the rolling contact surface (**Photo 1**). The thermal effects of the sparks can cause the metallurgical composition and hardness in this problematic area to differ from those of

the surrounding normal areas, resulting in a white layer, hardened layer and tempered layer. As a result, the problematic area can eventually develop flaking. Furthermore, if the electrical pitting phenomenon progresses, a corrugation pattern (**Photo 2**) can develop that increases running noise and vibration. Consequently, the bearing can no longer adequately function.

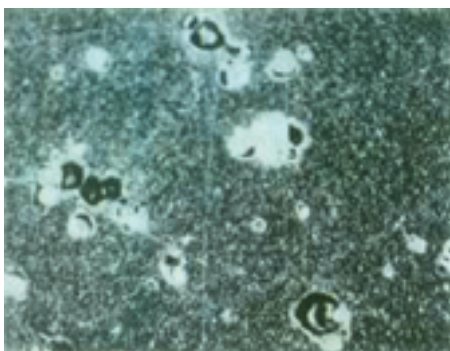

Photo 1



Photo 3

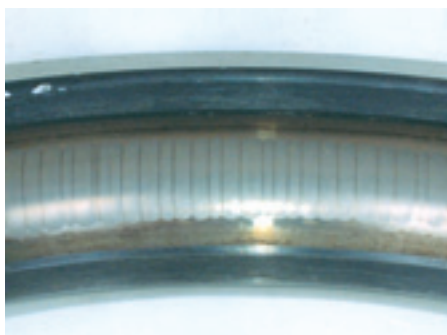

Photo 2

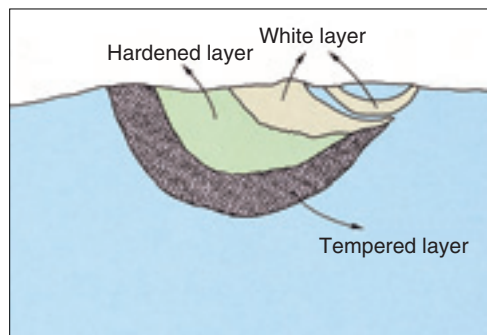

Fig. 1

# 2

## Specifications

### Ceramic Insulated Bearings



### Resin Insulated Bearings



Standard type

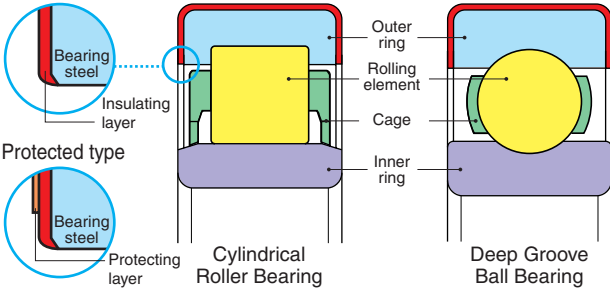

Protected type

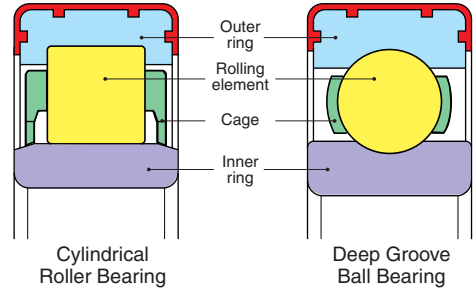
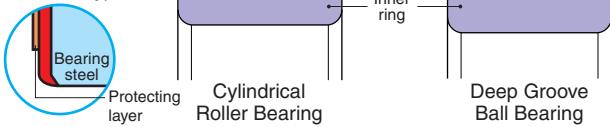

### Bearing Numbers

#### Ceramic insulated bearings

**7MC3 - 6330M2C3**

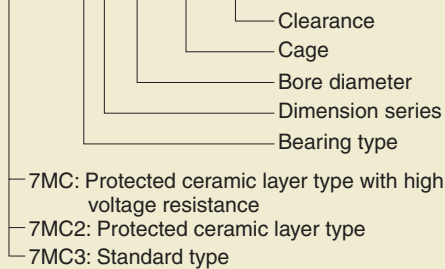

#### Resin insulated bearings

**7MP - NU214L1BC4P6**

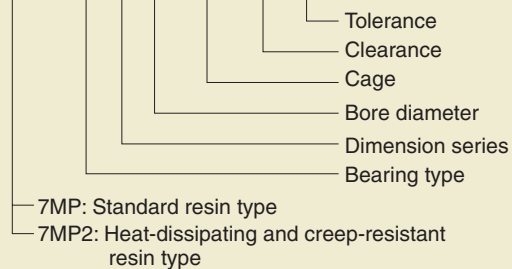

#### High voltage resistance

- 7MC : 5kV
- 7MC2 : 3kV
- 7MC3 : 3kV
- 7MP : 5kV
- 7MP2 : 5kV

Note: The insulated bearings MEGAOHM™ Series includes a range of high-temperature models. For technical assistance, contact NTN Engineering.

# 3

## Performance

The various features of the insulated bearings MEGAOHM™ Series are summarized below. Choose the configuration that best suits your application.

	Ceramic	Resin	Ceramic Rolling Element (reference)
Insulation performance	◎	◎	◎
Creep resistance	◎	○	◎
Heat dissipation	◎	○	◎
Shock immunity	○	○	◎
Price	○	◎	△

- ◎ : Excellent
- : Normal
- △ : Poor



4

Dimension Tables for Ceramic Insulated Bearings

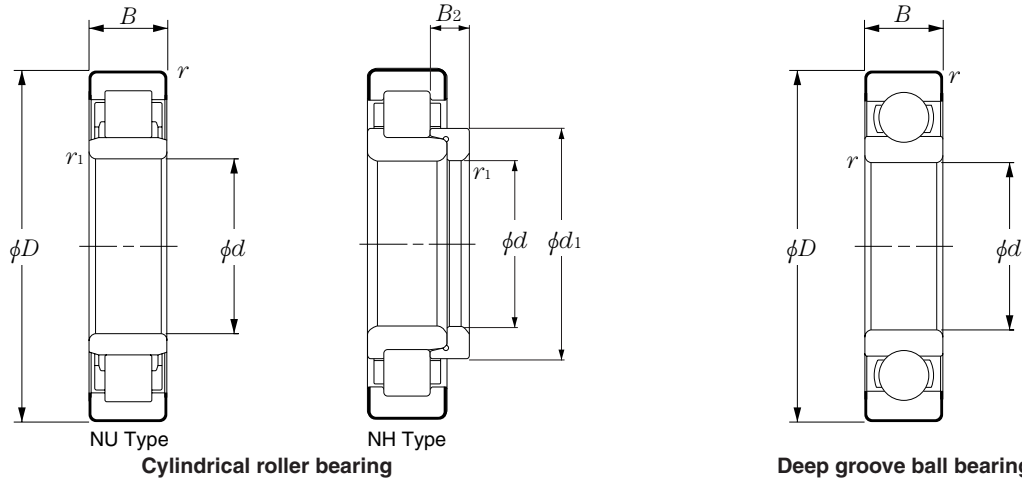

Bearing types	Bearing numbers	Boundary dimensions				Basic load ratings		Collar ring numbers	Boundary dimensions					Required shoulder height	
		mm				Dynamic	Static		mm					mm	
		$d$	$D$	$B$	$r_{1s}$ min	N $C_r$	N $C_{or}$		$d$	$d_1$	$B_1$	$B_2$	$r_{1s}$ min	max	min
Cylindrical roller bearing	7MC (n) -NU214	70	125	24	1.5	83 500	95 000	—	—	—	—	—	—	117	109
	7MC (n) -NU314	70	150	35	2.1	158 000	168 000	—	—	—	—	—	—	139	126.5
	7MC (n) -NU316	80	170	39	2.1	201 000	223 000	—	—	—	—	—	—	159	143.2
	7MC (n) -NH318	90	190	43	3	240 000	265 000	HJ318	90	125	12	21	3	177	163.8
	7MC (n) -NH320	100	215	47	3	299 000	335 000	HJ320	100	140.5	13	22.5	3	202	180.3
	7MC (n) -NH322	110	240	50	3	360 000	400 000	HJ322	110	155.5	14	23	3	227	200.9
	7MC (n) -NU326	130	280	58	4	560 000	665 000	—	—	—	—	—	—	264	235.9
	7MC (n) -NU330	150	320	65	4	665 000	805 000	—	—	—	—	—	—	304	268.9
Deep groove ball bearing	7MC (n) -6311	55	120	29	2	71 500	45 000	—	—	—	—	—	—	111	104.5
	7MC (n) -6312	60	130	31	2.1	82 000	52 000	—	—	—	—	—	—	119	112.6
	7MC (n) -6316	80	170	39	2.1	123 000	86 500	—	—	—	—	—	—	159	150.7
	7MC (n) -6324	120	260	55	3	207 000	185 000	—	—	—	—	—	—	247	225.6
	7MC (n) -6230	150	270	45	3	176 000	168 000	—	—	—	—	—	—	257	240.2
	7MC (n) -6330	150	320	65	4	274 000	284 000	—	—	—	—	—	—	304	275.9

Notes : For bearing clearances and cage types, contact NTN Engineering.  
The bearing numbers listed here refer to current products. For bearings with other numbers, contact NTN Engineering.

- 7MC(n) — 7MC: Protected ceramic layer type with high voltage resistance
- 7MC2: Protected ceramic layer type
- 7MC3: Standard type

※Required shoulder height

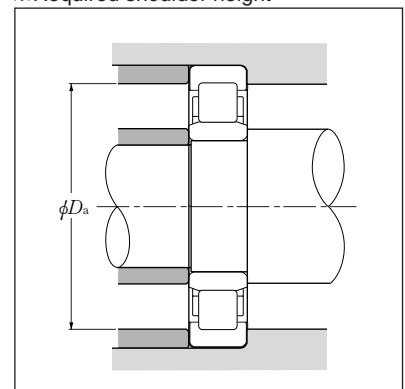

5

## Dimension Tables for Resin Insulated Bearings

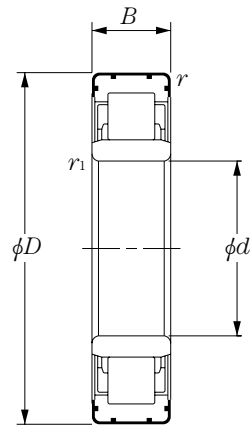

Cylindrical roller bearing

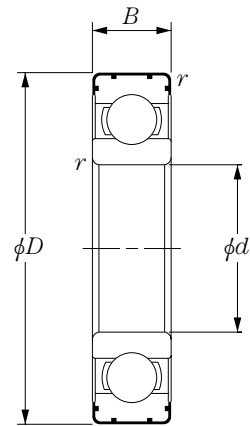

Deep groove ball bearing

Bearing types	Bearing numbers	Boundary dimensions				Basic load ratings		Required shoulder height mm $D_a$ max
		mm				Dynamic N $C_r$	Static N $C_{or}$	
		$d$	$D$	$B$	$r_s$ min			
Cylindrical roller bearing	7MP-NUP208	40	80	18	1.1	43 500	43 000	73.5
	7MP-NUP210	50	90	20	1.1	48 000	51 000	83.5
	7MP2-NU214	70	125	24	1.5	83 500	95 000	117
	7MP2-NU314	70	150	35	2.1	158 000	168 000	139
	7MP2-NU215	75	130	25	1.5	166 000	195 000	122
	7MP-NU315 ※	75	160	37	2.1	190 000	205 000	149
	7MP-NU316 ※	80	170	39	2.1	201 000	223 000	159
	7MP2-NU217	85	150	28	2	126 000	149 000	141
	7MP-NU1017 ※	85	130	22	1.1	74 500	95 500	123.5
	7MP-NU219 ※	95	170	32	2.1	166 000	195 000	159
	7MP-NU220 ※	100	180	34	2.1	183 000	217 000	169
Deep groove ball bearing	7MP2-6310	50	110	27	2	62 000	38 500	101
	7MP2-6311	55	120	29	2	71 500	45 000	111
	7MP2-6312	60	130	31	2.1	82 000	52 000	119
	7MP2-6314	70	150	35	2.1	104 000	68 000	139
	7MP-6215	75	130	25	1.5	66 000	49 500	122
	7MP-6316 ※	80	170	39	2.1	123 000	86 500	159
	7MP2-6217	85	150	28	2	83 500	64 000	141
	7MP-6318 ※	90	190	43	3	143 000	107 000	177
	7MP-6219 ※	95	170	32	2.1	109 000	82 000	159
	7MP-6319 ※	95	200	45	3	153 000	119 000	187
	7MP-6320 ※	100	215	47	3	173 000	141 000	202
	7MP-6322 ※	110	240	50	3	205 000	179 000	227
	7MP-6030 ※	150	225	35	2.1	126 000	126 000	214

Notes : For bearing clearances and cage types, contact NTN Engineering.

The bearing numbers listed here refer to current products. For bearings with other numbers, contact NTN Engineering.

※ Available only with a 7MP prefix.

6

Typical Applications

Electric Motors

The insulated bearings MEGAOHM™ Series is widely used in the traction motors of railway cars. The unique knowledge and experience NTN has gained from motor applications in railways- where safety is the No. 1 priority- have contributed to the greatly improved reliability of general-purpose motors.

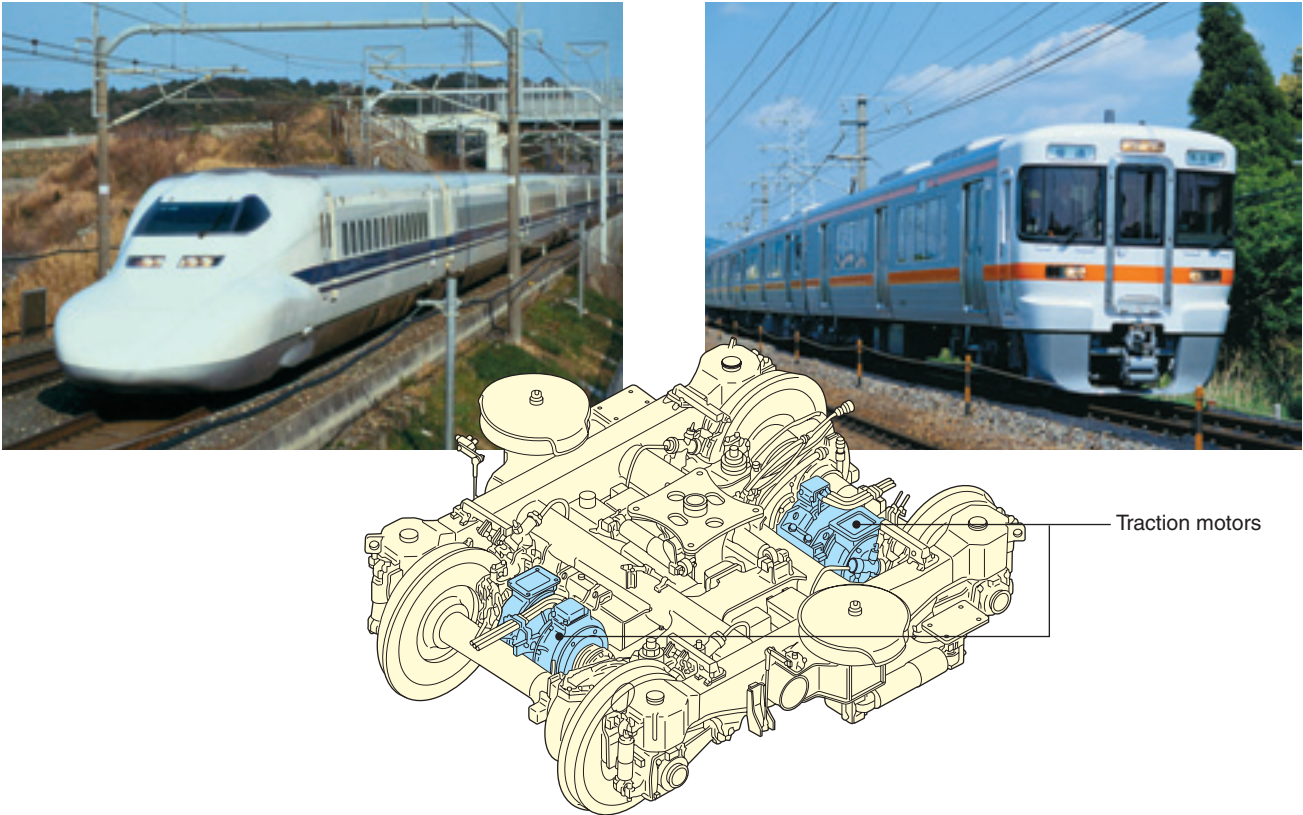

Power Generators

The insulated bearings MEGAOHM™ Series is also used in wind power generation systems, which are one solution to energy issues such as the prevention of global warming. These bearings contribute to the improved reliability of eco-friendly wind power generation systems.

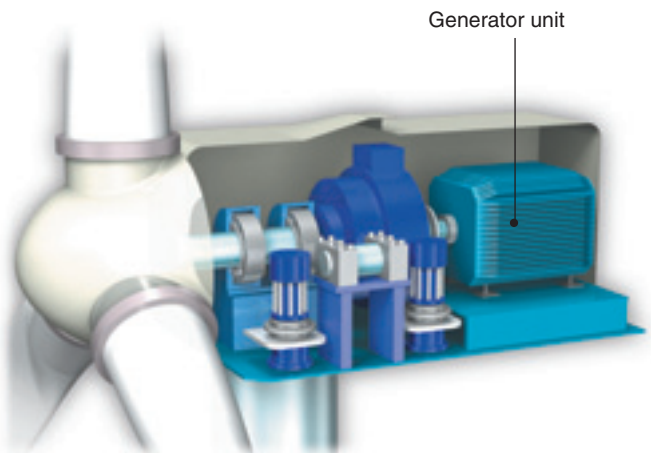

## Operating Precautions

To avoid an accident or failure resulting from damage to insulated bearings, carefully observe the following.

- Never drop an insulated bearing or strike it directly with a hammer during installation (**Illustrations 1 and 2**).
- Do not use an insulated bearing if a defect is visible on the surface (**Illustration 3**) or it has an unusual appearance.
- Attaching an electrical conductor to an insulated bearing can lower the bearing's insulation resistance.
- To prevent current flow from the side faces of a bearing, strictly observe the mounting dimensions given in the dimension tables for required shoulder height.
- Providing approximately 15° of relief (illustrated at right) at the entrance to the housing will facilitate assembly.
- For DC motors such as those used in railway cars, earth-ground the shaft during a voltage resistance test.

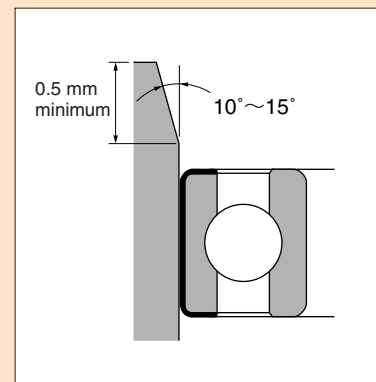

Relief at entrance of housing bore

Excessive shock can damage the insulating layer, possibly resulting in electrical pitting. Electrical pitting can in turn damage the bearing, leading to abnormal bearing performance and possible faulty operation or failure.

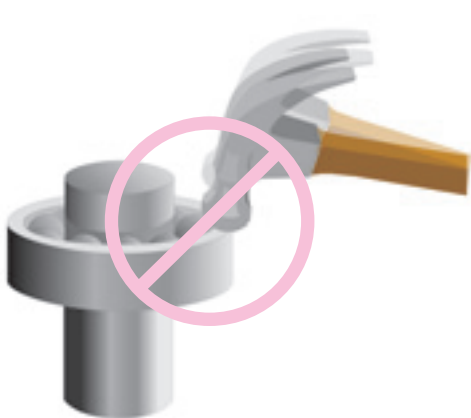

Illustration 1



Illustration 2



Illustration 3