

SPACEA™ Series Bearings for Clean Environments

- Virtually no particle emissions
- Optimum performance at high temperatures



Part of NSK's SPACEA Series for special environments, these bearings for clean environments utilize stainless steel combined with NSK cleanroom grease, LDF (special fluoro-resin) coating, self-lubricating fluorine resin and/or ceramics. They are especially suitable for liquid crystal and semiconductor manufacturing equipment.

Bearings for Clean Environments

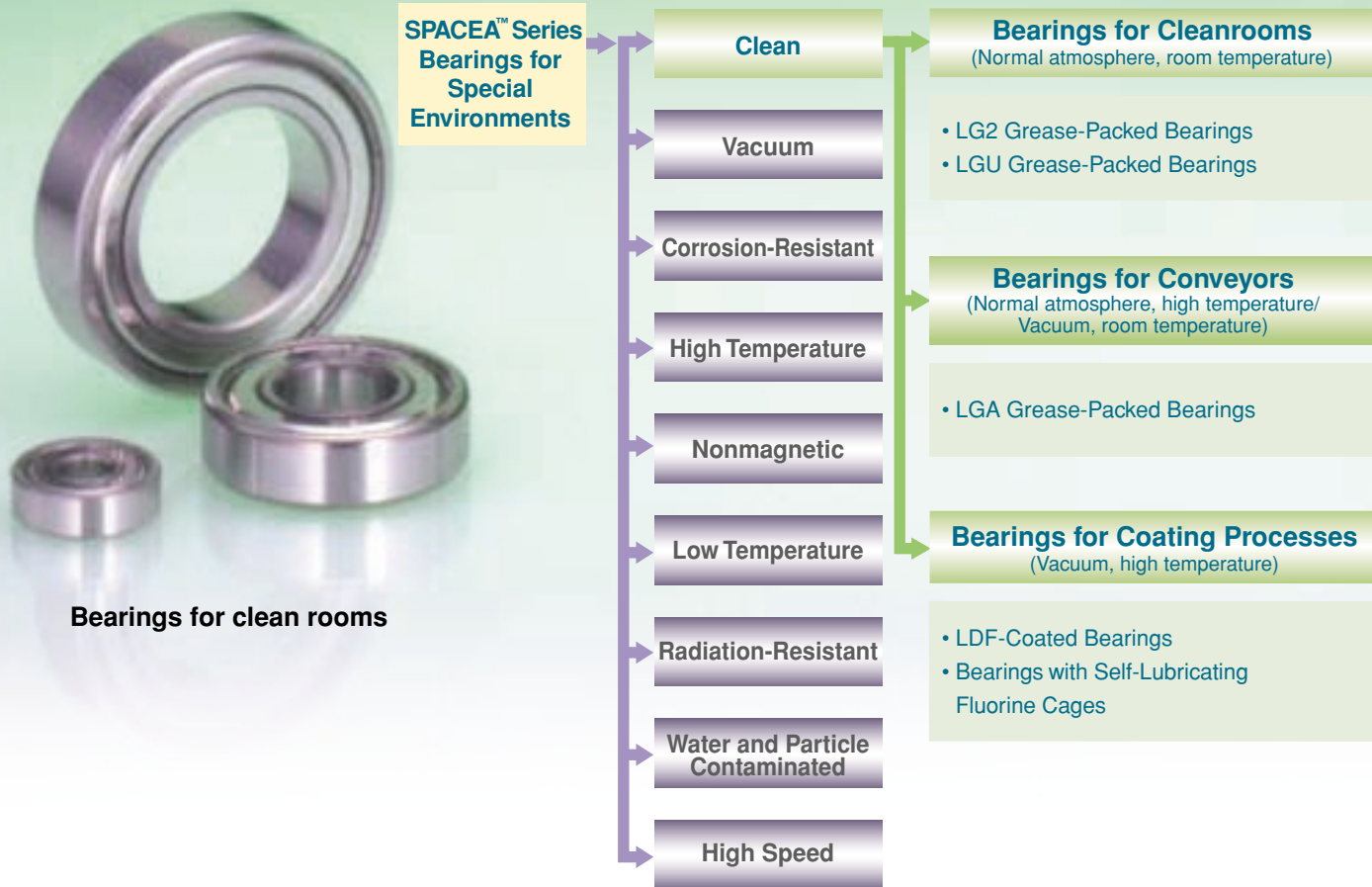

Application Ranges of Bearings for Clean Environments

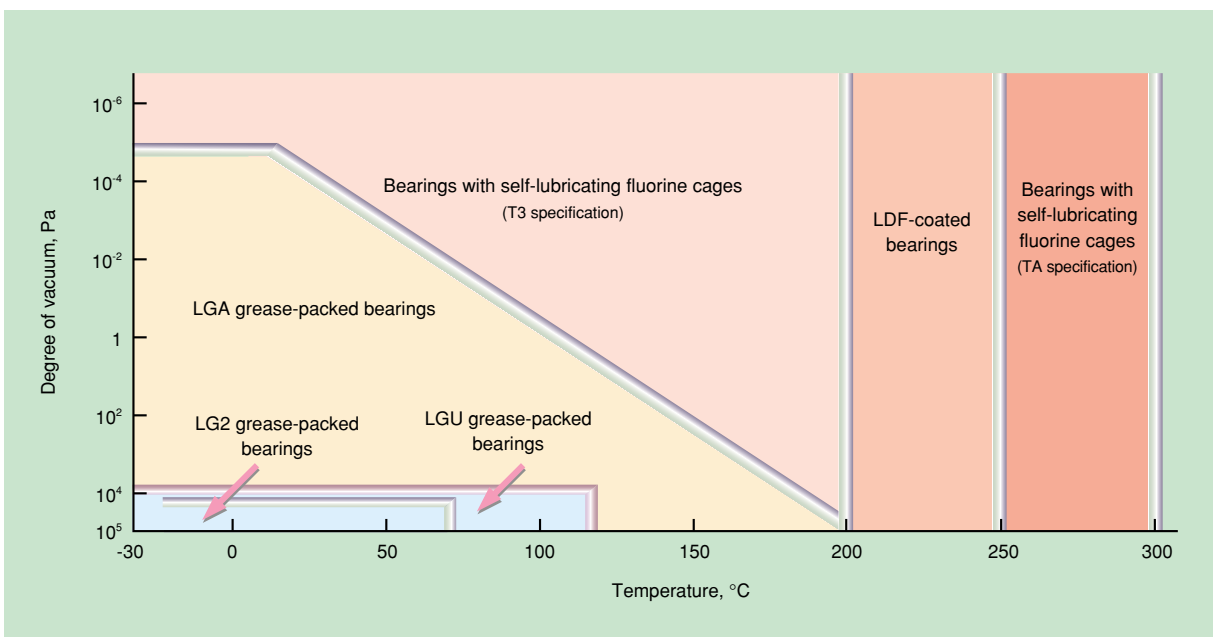

Note: LDF-coated bearings and bearings with self-lubricating fluorine cages can also be used under the operating conditions of the grease-packed bearings.

SPACEA™ Series Bearings for Clean Environments



Bearings for conveyors

Bearings for coating processes

Types of Bearings for Clean Environments

Application	Bearing type and nomenclature	Bearing specifications	Operating conditions			
			Temperature	Normal atmosphere	Vacuum	
Cleanrooms	LG2 grease-packed bearings Example: 608LZZ-H, LG2	Outer/inner rings: Stainless steel Balls: Stainless steel Cage: Resin or stainless steel Lubrication: LG2 grease Shields: Stainless steel	70°C max	Yes	No	
	LGU grease-packed bearings Example: 608LZZ-H, LGU	Outer/inner rings: Stainless steel Balls: Stainless steel Cage: Resin or stainless steel Lubrication: LGU grease Shields: Stainless steel	120°C max	Yes	No	
Conveyors	LGA grease-packed bearings Example: 608LZZC3-H, LGA	Outer/inner rings: Stainless steel Balls: Stainless steel Cage: Resin or stainless steel Lubrication: LGA grease Shields: Stainless steel	40°C max	Yes	Yes	
			200°C max	Yes	No	
Coating processes	LDF-coated bearings Example: 6001LZZC4- HPF	Outer/inner rings: Stainless steel Balls: Stainless steel or ceramics Cage: Stainless steel + LDF coating Lubrication: Solid lubricant (fluororesin) Shields: Stainless steel	250°C max	Yes	Yes	
	Bearings with self-lubricating fluorine cages	T3 specification Example: 6001LZZC3- HT3	Outer/inner rings: Stainless steel Balls: Stainless steel or ceramics Cages: Self-lubricating fluorine resin Lubrication: Solid lubricant (fluororesin) Shields: Stainless steel	200°C max	Yes	Yes
		TA specification Example: 6002LZZC4- HTA		300°C max	Yes	Yes

Bearings for Cleanrooms (Normal atmosphere, room temperature)

Bearings with LG2 and LGU Grease

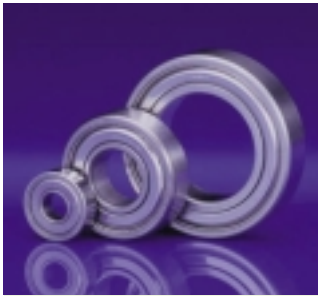

Structure

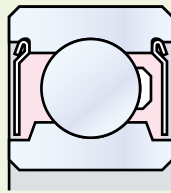

Standard Specifications

Outer/inner rings	Martensitic stainless steel
Balls	Martensitic stainless steel
Cage	Resin or stainless steel
Lubrication	LG2 or LGU Cleanroom Grease
Shields	Stainless steel

Features

- Compared to fluorine grease, LG2 and LGU have:
 - Lower particle emissions
 - Lower and more stable torque
 - Longer life and superior rust prevention
- LGU is free from metallic elements
- Temperature ranges:
 - LG2: -20°C–70°C
 - LGU: -30°C–120°C

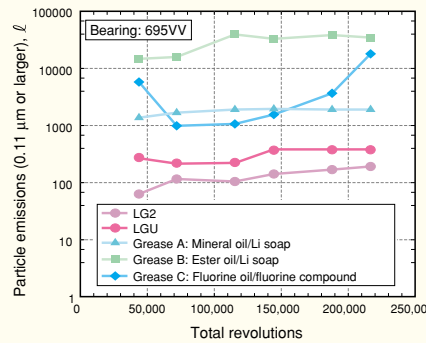

Fig. 1 Particle emissions of bearings with LG2, LGU and competing greases

Major Applications

Atmospheric and room temperature

- Liquid crystal and semiconductor manufacturing equipment
- Hard disk manufacturing equipment
- Food processing equipment
- Medical equipment

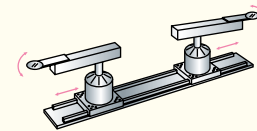

Fig. 2 Silicon wafer transfer robot

Bearing Nomenclature: LZZ-HT1, **LG2** or **LGU**

Bearings for Conveyors (Normal atmosphere, high temperature/Vacuum, room temperature)

LGA Grease-Packed Bearings



Structure

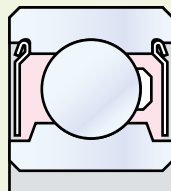

Standard Specifications

Outer/inner rings	Martensitic stainless steel
Balls	Martensitic stainless steel
Cage	Resin or stainless steel
Lubrication	LGA Grease (Wear-resistant fluorine grease)
Shields	Stainless steel

Major Applications

Normal atmosphere, high temperature/ Vacuum, room temperature

- Liquid crystal and semiconductor manufacturing equipment
- Hard disk manufacturing equipment
- Food processing equipment

Features

- Greater durability than obtained with fluorine grease (Fig. 3)
- Low particle emissions in vacuum environments (Fig. 4)
- Low vapor pressure

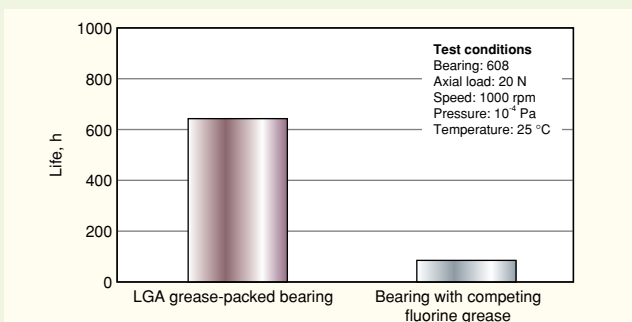

Fig. 3 Bearing durability in vacuum environment

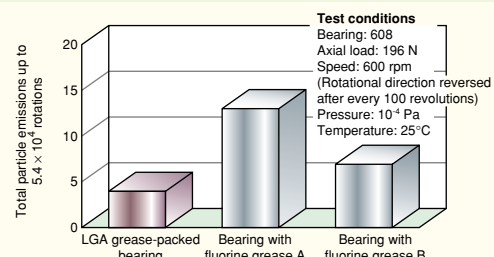

Fig. 4 Particle emissions of bearings in vacuum environment

Bearing Nomenclature: LZZC3-H, **LGA**

Bearings for Coating Processes (Vacuum, high temperature)

LDF-Coated Bearings



Structure

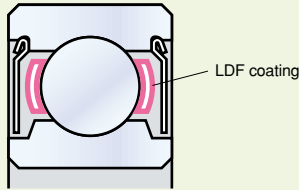

Standard Specifications

Outer/inner rings	Martensitic stainless steel
Balls	Martensitic stainless steel or ceramics
Cage	Stainless steel + LDF coating
Lubrication	LDF coating
Shields	Stainless steel

Features

- Low particle emissions in normal atmosphere and vacuum environments (Fig. 5)
- Excellent heat resistance
- Long life
- Low outgassing

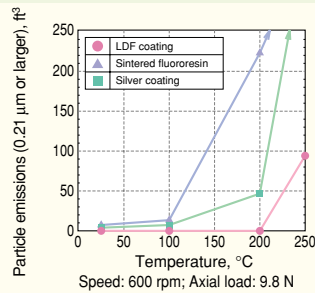

Fig. 5 Particle emissions of bearings in high-temperature, vacuum environment

Major Applications

Vacuum, high temperature

Sputtering equipment (Fig. 6)

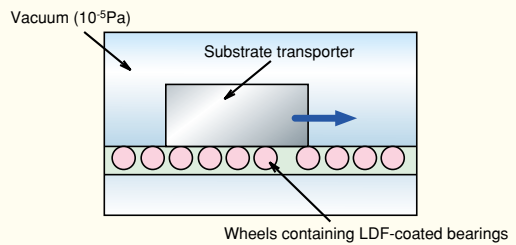

Fig. 6 Sputtering equipment

Bearing Nomenclature: LZZC4-HPF

Bearings with Self-Lubricating Fluorine Resin Cages



Structure

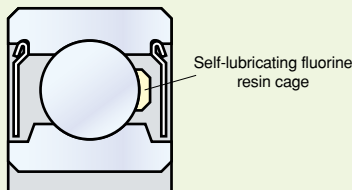

Standard Specifications

Outer/inner rings	Martensitic stainless steel
Balls	Martensitic stainless steel or ceramics
Cage	Self-lubricating fluorine resin
Lubrication	Provided by cage
Shields	Stainless steel

Features

- Long life
- Low particle emissions in normal atmosphere and vacuum environments (Fig. 7)
- Excellent heat resistance (T3 specification: up to 200°C; TA specification: up to 300°C)
- Low outgassing (Fig. 8)

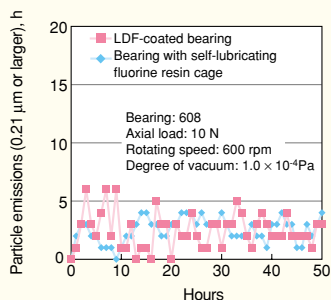

Fig. 7 Particle emissions in vacuum environment

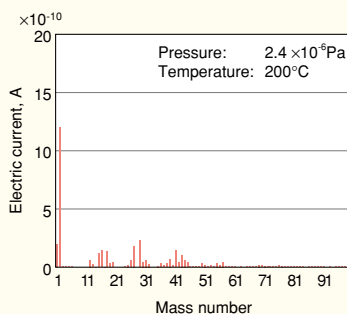

Fig. 8 Analysis results on outgassing

Major Applications

Vacuum, high temperature

Sputtering equipment (Fig. 6)

Liquid crystal and semiconductor manufacturing equipment

Hard disk manufacturing equipment

Solar cell manufacturing equipment

Robots for vacuum environments

Bearing Nomenclature:

LZZC3-HT3
(Up to 200°C)

LZZC4-HTA
(Up to 300°C)

SPACEA™ Series Bearings for Clean Environments

Standard Bearing Numbers

Shaft diameter (mm)	Basic bearing number	Boundary dimensions (mm)		
		Bore diameter	Outside diameter	Width
4	604	4	12	4
	624	4	13	5
5	605	5	14	5
	625	5	16	5
6	686	6	13	5
	696	6	15	5
	606	6	17	6
	626	6	19	6
7	687	7	14	5
	697	7	17	5
	607	7	19	6
	627	7	22	7
8	688	8	16	5
	698	8	19	6
	608	8	22	7
	628	8	24	8
9	689	9	17	5
	699	9	20	6
	609	9	24	7
	629	9	26	8
9.525	R6	9.525	22.225	7.142
10	6800	10	19	5
	6900	10	22	6
	6000	10	26	8
	6200	10	30	9
12	6801	12	21	5
	6901	12	24	6
	6001	12	28	8
	6201	12	32	10

Shaft diameter (mm)	Basic bearing number	Boundary dimensions (mm)		
		Bore diameter	Outside diameter	Width
15	6802	15	24	5
	6902	15	28	7
	6002	15	32	9
	6202	15	35	11
17	6803	17	26	5
	6903	17	30	7
	6003	17	35	10
	6203	17	40	12
20	6804	20	32	7
	6904	20	37	9
	6004	20	42	12
	6204	20	47	14
25	6805	25	37	7
	6905	25	42	9
	6005	25	47	12
	6205	25	52	15
30	6006	30	55	13
	6206	30	62	16
35	6007	35	62	14
	6207	35	72	17
40	6008	40	68	15
	6208	40	80	18

Addendum

The use of fluorine in the lubrication for bearings for clean, vacuum environments limits the bearings to light-load applications. For heavy-load applications in vacuum environments where low particle emissions are required, NSK recommends the three types of bearings with MoS₂ solid lubricant listed below.

Bearings with Self-Lubricating Cages (up to 200°C)

Structure

Please refer to catalog number E1227 for details.

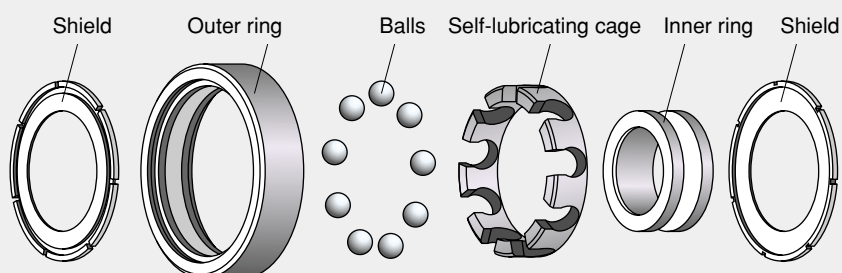

Features

- Lubrication with MoS₂ solid lubricant cage
- Long life in high-temperature vacuum environments (up to 200°C)
- Low particle emissions
- Low outgassing

Bearing Nomenclature

□ **LZZC3-HMST4**

Availability

Ball bearings with bore diameters of 4 mm or more

Bearings with Self-Lubricating Spacer Joints (up to 350°C)

Structure

Please refer to catalog number E1227 for details.

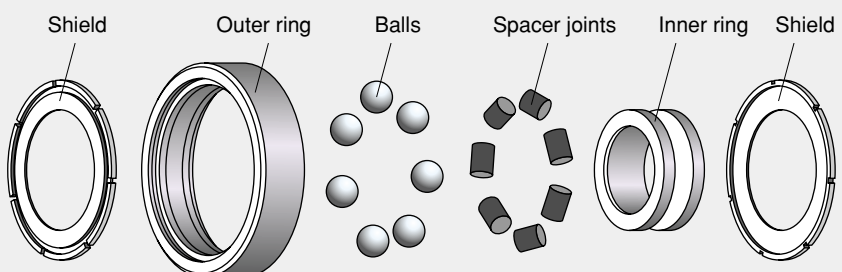

Features

- Lubrication with MoS₂ solid lubricant spacer joints
- Long life in high-temperature vacuum environments (up to 350°C)
- Low outgassing

Bearing Nomenclature

□ **LZZC4-HMSS2**

Availability

Ball bearings with bore diameters of 6 mm or more

SJ Bearings (up to 400°C)

Structure

Please refer to catalog number E1223 for details.

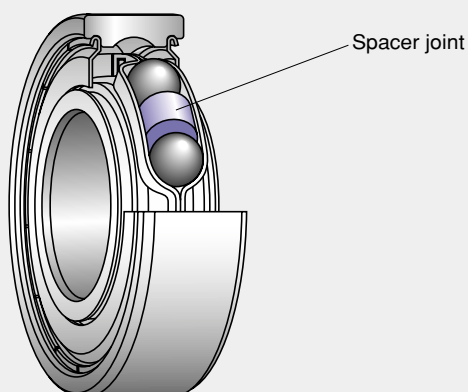

Features

- Lubrication with MoS₂ solid lubricant spacer joints using a specially shaped cage
- Long life in high-temperature vacuum and normal environments (up to 400°C)
- Low outgassing

Bearing Nomenclature

□ **LZZ-HMLSJ**

Availability

Bearing nos. 608, 6000, 6001, 6002, 6003, 6004, 6200, 6201, 6202 and 6203